



MADE IN GERMANY



INDUSTRIAL TECHNOLOGIES

TUNGSTEN CARBIDE



BETEK TUNGSTEN CARBIDE TOOLS

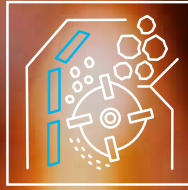

INDUSTRIAL  
TECHNOLOGIES

- CRUSHING & MIXING
- TUNGSTEN CARBIDE
- RAIL TRACK CONSTRUCTION
- INDUSTRIAL SOLUTIONS

IN USE WORLDWIDE

# TUNGSTEN CARBIDE AND STEEL

Steel and carbide are two materials with totally different expansion coefficients when subjected to heat. Nevertheless, it is of steel and tungsten carbide that our tools are made, with tungsten carbide for the wear-resistant tip, and steel for the tool shank. Since tools reach high temperatures during use, extreme tensile stresses are generated. These stresses are absorbed by a special brazing material that joins the tungsten carbide tip to the steel section.

We have developed our own methods and systems for this brazing process, which is carried out on fully automated machines with the process covered in an inert protective gas. Manufacturing parameters are fully monitored and documented to ensure consistent quality. Afterwards, brazing shear strengths are checked to ensure that our "Masters of the construction site" lose no time due to broken tools!

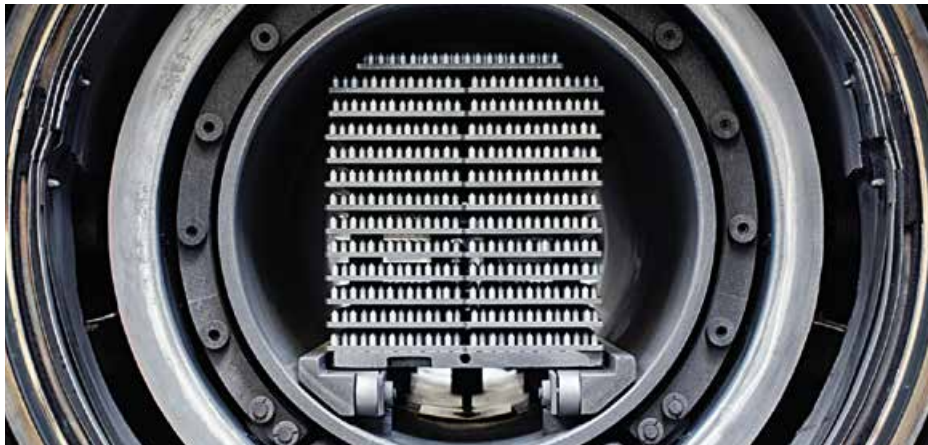

# BETEK HIGH-TECH TOOLS



1

## CUSTOMER SERVICE

- Efficient, customised solutions based on flexible structures
- Personalised, quick response to customer requirements



2

## RESEARCH & DEVELOPMENT

- Quick creation of samples and prototypes
- Competitive pricing thanks to close cooperation with all production units



3

## TUNGSTEN CARBIDE MANUFACTURING

- High-purity raw materials are used for high strength
- Consistently high, pore-free tungsten carbide quality through precise process control thanks to years of experience and know-how



4

## SOLDERING PRODUCTION UNIT

Production facilities and processes specially developed to perfection by experts in the combination of tungsten carbide and steel



5

#### **AUTOMATION**

Maintaining a competitive edge on the global market thanks to a high degree of automation and flexible manufacturing facilities



6

#### **QUALITY ASSURANCE**

Continuous quality testing of the entire manufacturing chain all the way up to the installation site, in conformity with DIN ISO 9001:2000 and DIN EN ISO 14001



7

#### **TRAINING**

User training courses at BETEK or on-site for sustainable, long-term commercial success and customer satisfaction



8

#### **LOGISTICS**

Quick responses thanks to:

- the use of the very latest IT and enhanced logistics networking
- Standard products kept in stock

OUR KNOW-HOW COMBINED WITH STATE-OF-THE-ART PRODUCTION TECHNOLOGIES GUARANTEES THE FINEST QUALITY, MADE IN GERMANY



# TUNGSTEN CARBIDE

## › THE RAW MATERIALS

---

The situation on the raw materials market is characterized by risk factors. Extreme price developments, challenging availability of raw materials due to export restrictions for political reasons and price increases are only a few of the factors that influence the market.

Numerous studies in recent years have addressed the question of how the supply of critical basic materials can be ensured. These basic materials, which are difficult to procure, are important for next generation technologies such as electromobility, information technology and renewable energies.

Raw materials are designated as critical if the high supply risk primarily results from the global raw material production being concentrated in a few countries. In many cases, the raw material is also difficult to replace and its recycling rate is low. The economic harm when supply is disrupted is also taken into consideration. According to the results of these studies, tungsten is a high-grade critical material.

### **TUNGSTEN:**

The greatest amount of tungsten, which BETEK requires for carbide production, is found in the People's Republic of China, which simultaneously has the world's highest demand. China's government has severely restricted the export rate and subsequently reduced intended export volumes; the risk of bottlenecks is high. Outside of China, tungsten deposits are found in the USA, Australia, Peru, Bolivia, Russia, Korea and Canada. In Europe and neighboring areas, there are a few extraction areas in Portugal, Spain, the UK and Austria. There have been efforts for several years to start new mines or reopen decommissioned mines outside of China. However, this is associated with high investment costs.

### **COBALT:**

Even if cobalt is not one of the rarest raw materials, it is also only extracted in a few countries. Critical areas such as the Republic of Congo, which covers nearly 50% of the world's demand, are among the suppliers here. Cobalt is required for high-tech developments such as super-alloys for aviation, catalytic converters, lithium-ion based batteries or medical technology applications. These developments force companies like BETEK to source alternatives early which can be used over the long term as substitutes for tungsten or cobalt. In order to be able to produce independently of market risks and dictated prices, BETEK is already accessing a large amount of raw materials from the European and Middle Eastern regions now.

The suppliers are simultaneously development partners of BETEK who have their own mines and recycling operations.

# TUNGSTEN CARBIDE

## › MATERIAL DEVELOPMENT

The SIMON company group has its own materials laboratory. When it comes to the analysis and development of carbide materials, examination of proprietary powder mixtures and granulates as well as the analysis of semi-finished and finished parts and sintered parts are essential for quality assurance, in addition to a careful analysis of delivered raw materials. The company group's laboratory performs a substantial part of the carbide analyses itself, such as hardness measurements, determination of magnetic properties and carbon content. Analyses of density, flexural strength and wear, particularly in the case of carbide qualities, are likewise part of the extensive analysis program. The laboratory has a great deal of experience and many years of established know-how in the field of carbide.

The laboratory is furnished with state-of-the-art equipment, e.g.: ICP spectrometer for element analysis, various light microscopes for assessment of micro-structures, scanning electron microscope with up to 10,000x magnification, a laboratory attritor for process and product development, a grinding block and a rotation evaporator as well as two lab furnaces for production-oriented sintering.

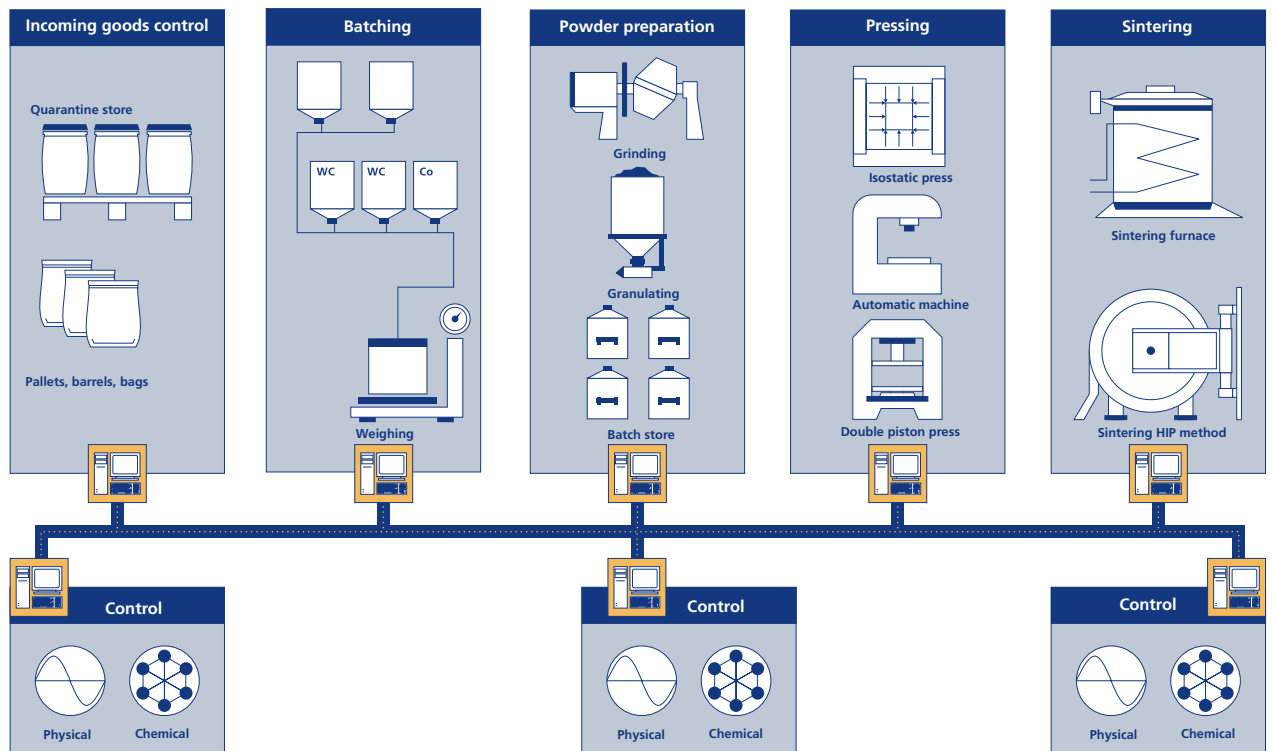



# QUALITY ASSURANCE

## ► ANALYSIS METHODS

**MICROSCOPY: SEM, LIGHT MICROSCOPE**



**DIGITAL PICTURE ARCHIVING**

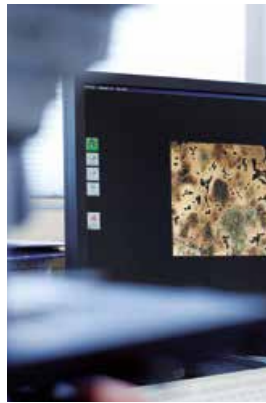

**LABORATORY ATTRITOR**



**ROTARY EVAPORATOR**



## QUALITY MEASUREMENTS

- Hardness testing
- Magnetic measurement carbide phase
- Magnetic measurement binder phase
- Bending fracture testing
- Tensile / pressure tests
- Wear simulation
- Microscopy
- SEM-Microscopy
- Material development in laboratory scale:
  - Powder mixture
  - Granulating
  - Drying
  - Pressing
  - Sintering
- Density measurement
- Carbon analytics
- Polished specimens of TC
- Spectral analysis for incoming goods control
- Measuring sintered part contours



# TC – FINISHING PROCESSES

## › READY FOR YOUR PRODUCT

After sintering, we can process your carbides by various methods or combinations of methods upon request, if the application requires special form and surface qualities, special dimensional accuracy or increased surface protection of the carbides, for example. We offer the grinding processes of centerless cylindrical grinding, slide grinding and a process for surface compaction.

Application areas for ground carbide pins:

- Tricone bits (press-fit)
- TH- and DTH bits (shrunk-in)
- High pressure grinding rolls (bonded)

BETEK has automatic centerless cylindrical grinding machines with high throughput and automatic feeding and monitoring elements, as well as smaller systems for mechanized processing of small-scale productions for testing purposes. Centrifugal force vibratory finishing systems which deburr carbides, round off edges and clean, mat and polish the carbide pins serve for vibratory finishing of carbides.

After grinding of the carbides, the carbides can be surface compacted upon request. The rotation in the grinding container produces a hardening effect in the carbides to be processed and the surface compacts during the rotation process to the desired maximum hardness value. At the same time, however, the exceptional properties in the interior of the carbides, toughness and high flexural strength are uniformly retained.



**SYSTEM FOR CENTERLESS CYLINDRICAL GRINDING.**



**DIAMETER INSPECTIONS ACCOMPANYING PRODUCTION ARE ALSO PERFORMED AT BETEK FOR QUALITY ASSURANCE.**

# TC – FINISHING, QUALITY MANAGEMENT

## ► TO ENSURE BEST QUALITY

All production steps during manufacturing as well as during finishing are optimized down to the last detail and monitored, controlled and improved as required.

### PRODUCTION:

From receipt of raw materials to spray drying and pressing to sintering, constant quality controls accompany the entire production process of the carbide. Exacting process control is decisive for quality in carbide production. This starts with the composition of the carbide powder, which varies according to the properties of the final products. The powders are compressed into form under electronic monitoring of the pressing parameters.

Consistency in the process control also applies during sintering, during which the pressed forms receive their exceptional carbide properties. Quality inspections permanently accompany all processes. This is also based on high values, so that the tools are free of cavities, have the optimal carbon content and exhibit the right flexural strength. Carbide must have high wear resistance but also have sufficient toughness. Every application requires a different ratio of hardness and toughness. As a leading specialist in this field, BETEK has specialized knowledge and experience here.

### FINISHING:

Our finishing processes are also consistently monitored in order to ensure the uniform quality of the final products: our products are also subjected to various controls during the different finishing stages, process-accompanying monitoring steps and subsequent final inspection. For example, diameter monitoring and geometric control of the carbides are performed during the grinding processes. The cylinder shape of our carbide pins are inspected on three planes — this allows for deviations on the tiniest scale to be ascertained and corrected.

The surface roughness of the carbides is measured so that the carbide inserts can later be optimally connected with the various steel tool bodies. The result are reliable and durable carbide inserts which prove themselves even under the most severe application conditions.

### THE MOST STATE-OF-THE-ART EQUIPMENT FOR DIMENSIONAL CONTROL OF THE GROUND INSERTS.



# TUNGSTEN CARBIDE GRADES

## ► GRADE RECOMMENDATION

Just give us a call or send us an e-mail, and we'll give you advice on all issues related to our TC. This includes advice on the choice of grades and shapes, which have to be matched to the intended job and the ground conditions.

Our support includes solving even the trickiest of problems and can extend all the way to developing new TCs or tools systems. We'll assist you in selecting from the different possibilities, and we can also manufacture individual solutions, on request. Just discuss your wear problem or application with us, and we'll find the most economical solution, even for applications in which steel is used for wear protection.

### TC SPECIFICATIONS WITH APPLICATION RECOMMENDATION:

TC grade	WC Balance %	Co Balance. % ±0,2	Average grain size * (µm)	Density (g/cm³) ± 0,20	Hardness HV 10 ± 50	Application recommendation
<b>FINE GRAIN SIZES</b>						
B-10-F/1	94,0	6,0	4 - 5	14,90	1400 ± 40	Down-the-hole (DTH) and TH (Top Hammers) for mining, water well, construction and oil drilling rotor tips for VSI crusher
B-10-F/1M	94,0	6,0	4 - 5	14,90	1430 ± 30	
B-10-F	94,0	6,0	4	14,90	1475	
B-10-F/2	94,0	6,0	3	14,95	1535	
<b>MIDDLE GRAIN SIZES</b>						
B-15	92,5	7,5	4 - 6	14,75	1350	Drill bits for overburden drilling
B-20	90,5	9,5	4 - 6	14,55	1300	Drill bits for overburden drilling and drill rods
B-25	90,0	10,0	4 - 6	14,50	1200	Tricone / Rotary Bits for mining, oil drilling, Mineral processing
B-30	89,0	11,0	5 - 7	14,40	1150	
BO-30	89,0	11,0	5 - 7	14,40	1200 ± 100	Foundation drilling, carbide plates for surface protection, snow plough tools
B-35	87,0	13,0	5	14,20	1110	Mineral processing
B-40	85,0	15,0	4 - 6	14,00	1030	Shredder tools, HDD, Tunneling and Agriculture, Mineral processing
BO-40	85,0	15,0	4 - 6	14,00	1100	
B-45	82,0	18,0	6	14,00	960	Mineral processing
B-50	80,0	20,0	6	14,00	900	Mineral processing
<b>COARSE GRAIN SIZES</b>						
B-10-G	94,0	6,0	20 - 25	14,90	1180	Road milling for Asphalt and Concrete
B-20-G	91,5	8,5	20 - 25	14,65	1050	Round shank cutter bits for Tunneling, Mining and Vertical Drilling, Trenching, Agriculture
B-25-G	90,5	9,5	20 - 25	14,55	1020	Shredder and Chipper Tools, Forestry Mulcher
B-40-G	85,0	15,0	20 - 25	14,00	900	Stone Splitting Tools, Teeth for Sizer and Double-Roll-Crusher

# APPLICATIONS

## ► TUNGSTEN CARBIDE BOTTOM SHAPES

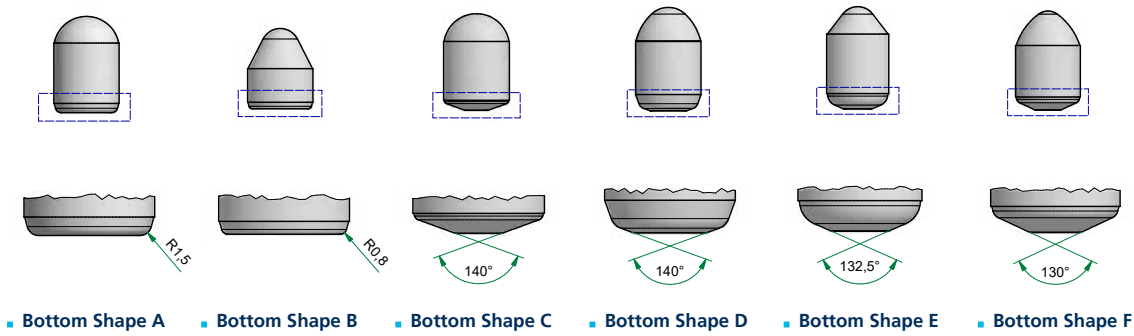

## ► TC FOR TRICONE BITS

Grade recommendations:

### B25:

BETEK recommends medium grain carbide grades for use in three-winged core drill bits / tricone bits / rotary bits, such as carbide B25 (fig.: structure image). This grade consists of 90% WC and 10% CO. It is suitable for soft, medium and hard rock in mining construction, oil drilling, HDD and water well drilling technology applications.

### B30:

This grade consists of 89% WC and 11% CO and is suitable for very hard rock, especially for use in iron ore extraction.

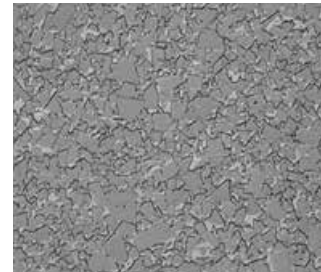

### HEMISPHERICAL SHAPE

Ø D mm	H mm	h1 mm	Bottom shape	Radius mm	TC grade	Description
10,3	10,0	1,6	B	9	B25	HM393
14,3	22,0	5,1	D	7,5	B25	HM774

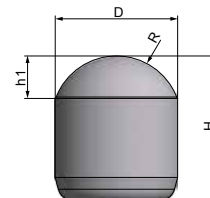

# APPLICATIONS

## ► TC FOR TRICONE BITS

### PARABOLIC / SEMI-BALLISTIC SHAPE

Ø D mm	H mm	h1 mm	Bottom shape	TC grade	Description
12,3	17,5	9,4	A	B25	HM425
12,3	17,5	9,1	B	B25	HM1376
12,4	21,7	8,3	C	B20	HM524

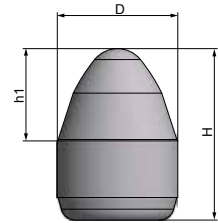

### TRICONE SHAPE

Ø D mm	H mm	h1 mm	Bottom shape	TC grade	Description
13,0	18,5	7,6	A	B25	HM478
14,3	20,0	9,1	A	B25	HM1369
14,4	20,0	9	A	B25	HM626
16,3	23,0	10	A	B25	HM1371
16,4	22,0	10,5	A	B25	HM1381
17,9	24,5	11,7	A	B25	HM1273

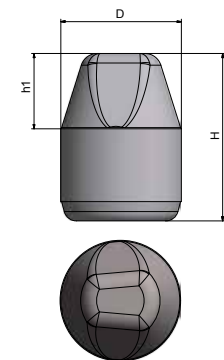

### ROOFTOP SHAPE

Ø D mm	H mm	h1 mm	Angle	Bottom shape	TC grade	Description
8,3	10,8	4,7	62	B	B25	HM366
11,3	12,5	6,7	65	B	B25	HM1369
11,3	14,5	6,7	65	A	B25	HM626
11,3	14,5	6,7	65	B	B25	HM1371
13,0	18,5	7,6	58	A	B25	HM1381
17,9	27,0	14	48	B	B25	HM1273

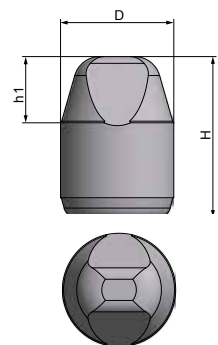

## TRICONE BITS

### CONICAL SHAPE

Ø D mm	H mm	h1 mm	Angle	Radius mm	Bottom shape	TC grade	Descrip- tion
8,3	9,8	4,6	53,7	2,8	B	B25	HM395
10,3	12,5	5,1	52	4,1	B	B25	HM428
11,3	14,0	5,6	52,2	4,5	A	B25	HM427
11,3	14,0	5,6	52,2	4,5	B	B25	HM1372
11,3	14,5	6,7	49	4	B	B25	HM1374
11,3	16,5	8,7	45	3	A	B25	HM392
11,3	16,5	8,5	45	3	B	B25	HM1375
12,3	15,7	7,2	50	4,2	B	B25	HM1384
12,3	15,7	6,5	48	5	A	B25	HM374
12,3	15,7	6,3	48	5	B	B25	HM1340
12,3	16,7	7,55	46	4,2	B	B25	HM1383
12,3	16,7	6,5	47,8	5	A	B25	HM375
12,3	16,7	6,3	47,8	5	B	B25	HM1370
12,3	17,5	9,6	50	2,5	B	B25	HM1377
13,0	16,5	5,7	60	5,5	A	B25	HM556
13,0	16,5	5,6	60	5,5	B	B25	HM1380
13,0	18,0	7,3	31	5,8	B	B25	HM1379
13,0	18,0	7,5	46,5	4,8	B	B25	HM1444
13,0	18,0	8,2	43,4	4,6	B	B25	HM1385
13,0	19,0	10,2	50	2,6	A	B25	HM307
13,0	19,0	10,1	50	2,6	B	B25	HM1382
13,0	19,5	10,2	41,2	3,8	A	B25	HM470
13,0	19,5	10	41,2	3,8	B	B25	HM1378
14,3	16,5	8,2	46	5,5	A	B25	HM484
14,3	17,0	7,2	56	5,5	A	B25	HM605
14,3	19,0	7,2	44,8	6,2	B	B25	HM1248
14,3	19,0	7,2	56	5,5	A	B25	HM628
14,3	19,0	8,2	54,3	4,8	B	B25	HM1249
14,3	20,0	9,2	38	5,5	A	B25	HM629
14,3	20,0	8,2	38	6	B	B25	HM1247
14,3	20,0	9,7	45,4	4,6	B	B25	HM1246
14,3	20,0	10,1	38	5	A	B25	HM616
14,3	21,0	11,3	42,4	4	A	B25	HM391

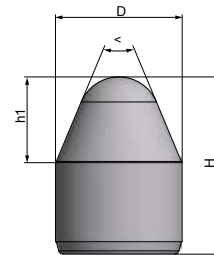
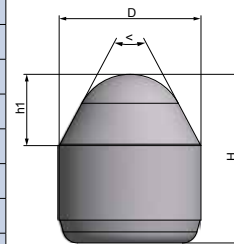

# APPLICATIONS

## ► TC FOR TRICONE BITS

### CONICAL SHAPE

Ø D mm	H mm	h1 mm	Angle	Radius mm	Bottom shape	TC grade	Descrip- tion
16,3	18,0	9,2	50	6	A	B25	HM483
16,3	20,0	9,2	50	6	A	B25	HM658
16,3	20,0	10	54,2	4,8	B	B25	HM1252
16,3	21,0	8,2	48,6	6,8	A	B25	HM409
16,3	21,0	10	54,2	4,8	B	B25	HM1251
16,3	22,0	11,3	42	5,5	A	B25	HM615
16,3	23,0	12,2	54,4	3	A	B25	HM317
16,3	23,5	12,6	40	5	A	B25	HM467
16,3	24,0	11,1	42	5,5	B	B25	HM1262
16,3	24,0	11,3	42	5,5	A	B25	HM597
16,3	24,5	13,8	41,4	4,2	A	B25	HM316
16,3	25,5	12,6	40	5	A	B25	HM053
16,4	21,0	10	43,4	6	A	B25	HM1017
16,4	22,0	11	46,8	5	A	B25	HM1018

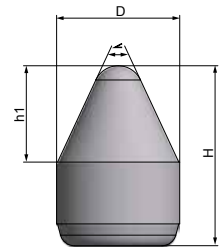



## TRICONE BITS

### CONICAL SHAPE

Ø D mm	H mm	h1 mm	Angle	Radius mm	Bottom shape	TC grade	Description
17,9	22,5	8,6	51	7,5	A	B25	HM611
17,9	28,0	15,3	46	3,5	B	B25	HM378
17,9	20,5	8,5	51,2	7,5	A	B25	HM1010
17,9	28,0	15	38,6	5	A	B25	HM1012
17,9	29,0	16	38,6	4,5	A	B25	HM1062
17,9	30,0	16	38,6	4,5	A	B25	HM1013
17,9	30,0	15	29,5	6,35	B	B25	HM1390
19,3	23,5	11,2	47	7,2	A	B25	HM417
19,3	25,5	10,8	45	7,7	A	B25	HM415
19,3	25,0	11,2	47	7,2	A	B25	HM416
19,3	30,5	16,8	45,8	3,8	A	B25	HM373
19,3	32,0	17,7	35	5,5	B	B25	HM1391

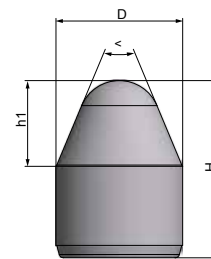

### SERRATED SHAPE

Ø D1 mm	Ø D2 mm	H mm	TC grade	Description
6,5	5,7	4,7	B25	HM613
8,3	7,1	6,5	B20	HM612
9,8	8,8	8,2	B20	HM663

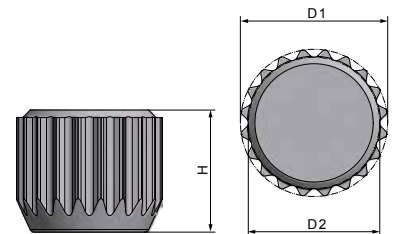

# APPLICATIONS

## › TH- & DTH-BITS

### GRADE RECOMMENDATION:

In addition to the tried and tested grades, BETEK has also developed additional carbide qualities for use on in-hole hammer drills (TH- and DTH bits) and covers the entire range of requirements for the use of tools in the fields of mining, tunneling, construction and water wells. The carbide grades used here are fine grain qualities with low binder ratio of 6% cobalt. Fig.: structure image of grade B10F with the finest grain structure.

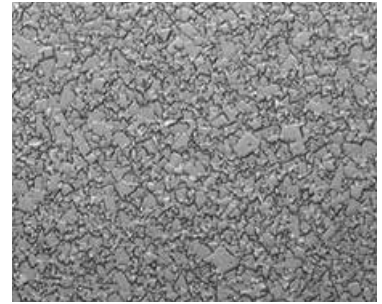

## › TC GRADE OVERVIEW FOR TH- & DTH-BITS

TC grade	WC weight %	Co weight %	Hardness HV 10 ± 50
B-10-F/1	94,0	6,0	1400 ± 40
B-10-F/1M	94,0	6,0	1430 ± 30
B-10-F	94,0	6,0	1475
B-10-F/2	94,0	6,0	1535



HEMISPHERICAL SHAPE

Ø D mm	H mm	h1 mm	Radius mm	Bottom shape	Description
7,4	10,5	2,6	3,8	C	HM1555
7,4	9,8	2,6	3,8	F	HM1767
8,2	11,4	2,7	4,3	C	HM1554
9,0	12,5	3,2	4,7	C	HM1449
9,0	14,2	3,2	4,7	C	HM1546
10,3	13,5	4,4	5,1	C	91520
10,3	13,5	4,4	5,1	F	HM1785
10,3	15,2	4,4	5,1	F	HM1781
10,6	14,2	3,5	5,6	C	HM1285
11,4	16,5	4	6	C	HM1188
11,4	17,8	4	5,9	E	HM504
11,3	12,8	4,9	5,6	F	HM1768
11,3	16,0	4,9	5,6	F	HM1632
12,3	18,0	4,1	6,5	D	HM736
12,4	18,0	4,7	6,3	E	HM510
12,4	18,3	4,7	6,3	F	HM1799
13,0	19,0	4,5	6,8	C	HM1189
13,3	18,3	5,5	6,7	F	HM1784
14,3	22,0	4,9	7,5	D	HM774
14,4	22,0	5,8	7,25	E	HM509
14,3	15,3	5,7	7,2	F	HM1786
14,3	18,3	5,7	7,2	F	HM1769
14,6	22,7	5,4	7,5	C	HM1217
16,3	19,0	6,6	8,2	A	HM1436
16,3	24,0	6,6	8,2	A	HM1439
16,4	26,5	6,9	8,2	E	HM060
19,4	23,1	7,2	10	A	HM1441
19,4	28,6	7,2	10	A	HM1440

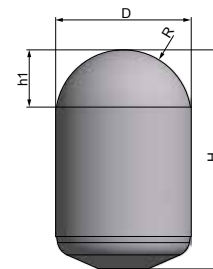
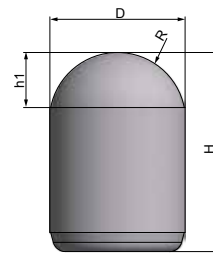

# APPLICATIONS

## ► TC FOR TH- & DTH-BITS

### PARABOLIC / SEMI-BALLISTIC SHAPE

Ø D mm	H mm	h1 mm	Bottom shape	Bottom shape	Description
7,4	10,5	3,4	B10F1M	F	HM1777
8,3	12,0	4,4	B10F1M	F	HM1778
9,4	12,5	4,7	B10F1M	F	HM1776
10,3	16,0	5,4	B10F	D	HM650
10,3	13,5	5,4	B10F1M	F	HM1797
10,3	16,0	5,4	B10F1M	F	HM1794
10,6	15,5	5,1	B10F1	C	HM1187
11,4	14,9	5,7	B10F1	C	HM1215
11,4	20,0	5,7	B10F1	C	HM1214
11,4	20,9	8	B10F	E	HM505
11,3	16,0	5,7	B10F1M	F	HM1779
12,3	19,0	6,5	B10F	D	HM651
12,4	21,7	8,3	B10F	E	HM524
12,4	19,0	6,6	B10F1	F	HM494
13,0	20,6	6,3	B10F1	C	HM1216
13,4	23,5	8,9	B10F	E	HM499
16,3	24,9	8,1	B10F1	A	91438

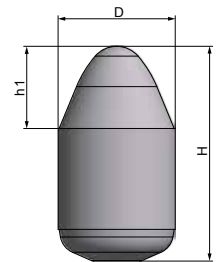
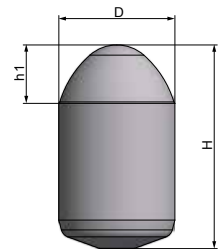
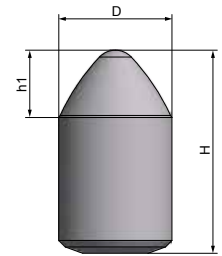

CONICAL SHAPE

Ø D mm	H mm	h1 mm	Radius mm	Angle	Bottom shape	Bottom shape	Descrip- tion
7,4	10,5	3,7	2,5	60	C	B10F1M	HM1260
8,2	11,4	4,2	3	57	C	B10F1	HM1185
9,0	13	4,7	3	60,8	C	B10F1	HM1186
9,0	14,2	4,7	3	60,8	C	B10F1	HM1448
10,3	16,5	4,6	3,15	75	D	B10F	HM935
10,3	17	4,7	3,15	75	D	B10F	HM466
11,3	18,4	6,4	1,5	75	D	B10F	HM956
11,4	19,3	5,4	3	75	C	B10F	HM492
12,3	19,5	5,8	3,5	75	D	B10F	HM728
12,4	19,5	6,8	3	67	E	B10F	HM465
14,3	23,7	6,6	4,2	75	D	B10F	HM729

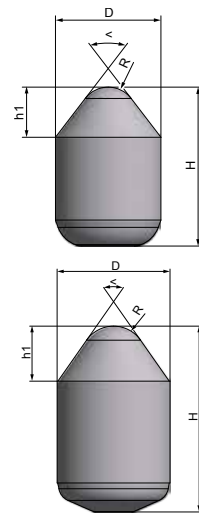

# APPLICATIONS

## ► TC FOR TUNNELLING

### ROOFTOP SHAPE

Ø D mm	H mm	h1 mm	Angle	TC grade	Description
7,0	12,0	3,3	90	BO-30	HM672
9,1	17,0	5,3	75	BO-30	HM885
15,4	24,0	8,5	66	B40	HM471
20,4	30,0	12,5	65	BO-40	HM464

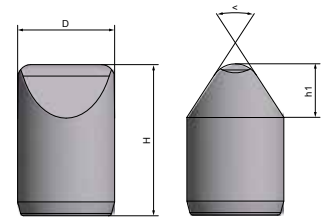

### PARABOLIC SHAPE

Ø D mm	H mm	h1 mm	TC grade	Description
14,8	24,0	8,3	B20G	HM888
17,4	28,5	10,5	B20G	HM816
18,9	29,0	11,0	B20G	HM305
24,8	35,0	13,4	B20G	HM445

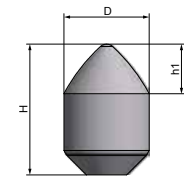

### FLAT TOP SHAPE

Ø D mm	H mm	TC grade	Description
7,0	8,4	B40	HM889
9,1	12,0	BO-30, BO-40	HM886
10,8	12,0	BO-30	HM742
12,3	14,0	BO-30	HM575
14,8	15,0	BO-30	HM890
17,8	17,0	BO-30	HM293

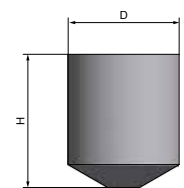

### BLOCK FOR SCRAPER BLADES I

B mm	L mm	H mm	TC grade	Description
33,0	14,9	40,0	B40	HM515

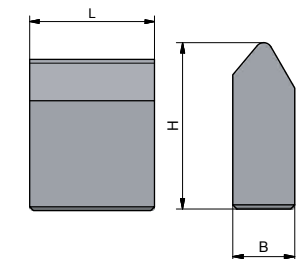

**BLOCK CENTER**

B mm	L mm	H mm	Angle	TC grade	Description
33,0	30,0	20,0	130	B25G, B40	HM299
38,0	25,0	15,0	130	B40	HM718
38,0	32,5	20,0	130	B25G, B40	HM877
50,0	32,7	19,3	130	B25G	HM660
50,0	45,0	29,8	130	B25G, B40	HM682

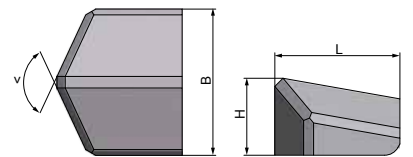

**BLOCK LEFT**

B mm	H mm	L mm	Angle	TC grade	Description
42,0	24,5	16,0	24,0	BO-40	HM012
42,0	32,0	20,0	24,0	B40	HM791

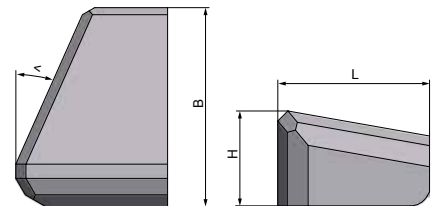

**BLOCK RIGHT**

B mm	H mm	L mm	Angle	TC grade	Description
42,0	24,5	16,0	24,0	BO-40	HM010
42,0	32,0	20,0	24,0	B40	HM792

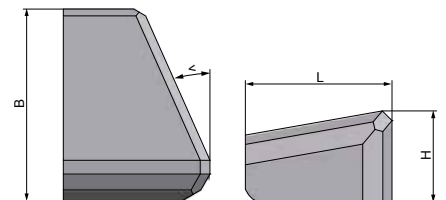

# APPLICATIONS

## ► TC FOR TUNNELLING

### BLOCK FOR SCRAPER BLADES II

B mm	H mm	L mm	TC grade	Description
19,0	10,0	25,0	B25G	HM343
19,0	11,8	26,7	B20G	HM794
23,0	11,8	26,7	B25G	HM858

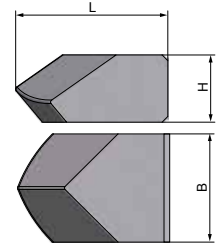

### PLATES FOR SCRAPER BLADES

L mm	B mm	H mm	Angle	TC grade	Description
20,0	11,0	6,0	80	BO-30	HM793
25,0	10,9	6,0	80	BO-30	HM866

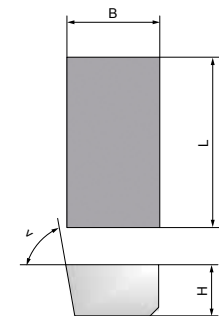



TC SYSTEMS FOR SCRAPER BLADES

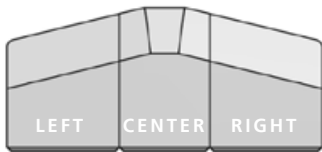

LEFT: 4902  
 CENTER: 4900  
 RIGHT: 4901

SCRAPER BLADES LEFT

System-Nr.	L mm	B mm	H mm	TC grade	Description
A	33,5	25,0	14,9	B40	HM902
B	43,7	25,0	14,9	B40G	HM969
C	43,6	33,0	15,0	B40	HM412

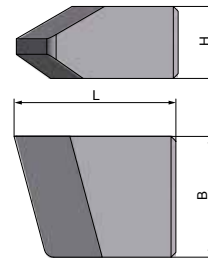

SCRAPER BLADES CENTER

System-Nr.	L1 mm	L mm	B mm	H	TC grade	Description
A	35,0	33,5	20,0	14,9	B40	HM900
B	49,6	43,7	20,0	14,9	B40G	HM970
C	43,0	43,6	33,0	15,0	B40	HM413

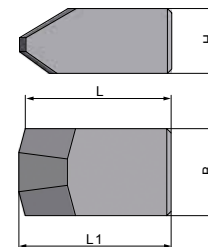

SCRAPER BLADES RIGHT

System-Nr.	L mm	B mm	H mm	TC grade	Description
A	33,5	25,0	14,9	B40	HM901
B	43,7	25,0	14,9	B40G	HM969
C	43,6	33,0	15,0	B40	HM412

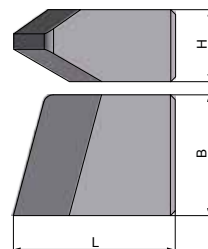

# APPLICATIONS

## ► TC FOR STONE SPLITTING TOOLS

### PLATES WITH RADIUS

L mm	B mm	H mm	Angle	Radius mm	TC grade	Description
39,0	11,9	20,0	90	74	B40G	HM905
48,0	11,9	20,0	90	84	B40G	HM892
58,0	13,9	25,0	90	120	B40G	HM298

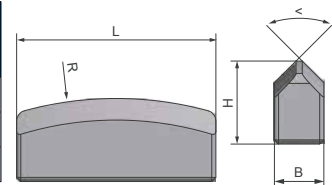

### PLATES WITHOUT RADIUS

L mm	B mm	H mm	Angle	TC grade	Description
25,0	7,9	16,0	80	BO-30	HM788
39,0	11,9	20,0	90	B40G	HM911
48,0	11,9	20,0	90	B40G	HM700

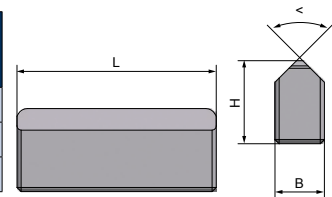

## ► TC FOR INTEGRAL DRILL STEEL AND ANCHOR DRILLING

### PLATES

L mm	B mm	H mm	Angle	TC grade	Description
34,5	9,9	17,9	6	B20	HM513
39,5	9,9	17,9	6	B20	HM514
40,5	9,9	17,9	6	B20	HM512

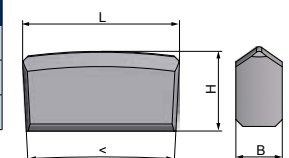



# APPLICATIONS

## ► TC FOR DIFFERENT WEAR SOLUTIONS

### ANCHOR-DRILLING SHAPE I

Ø D mm	H mm	h1 mm	TC grade	Description
15,7	24	9,7	BO-30	HM422

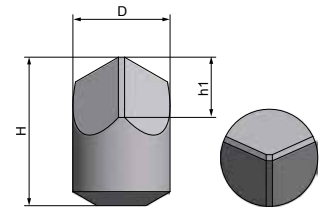

### ANCHOR-DRILLING SHAPE II

Ø D mm	H mm	h1 mm	TC grade	Description
12,3	19,85	7,15	B25	HM421
15,45	25	8,7	B25	HM1075

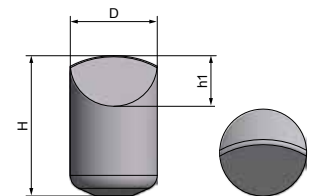

### PLATES SHAPE I

L mm	B mm	H mm	Angle	TC grade	Description
32,6	9,0	22,6	140	BO-30	HM444
50,0	10,0	25,0	143	BO-30	HM533

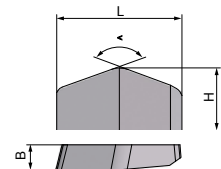

### PLATES SHAPE II

L mm	B mm	H mm	Variant	TC grade	Description
26,2	4,9	13,5	Uni	B20	HM469
50,0	6,4	22,0	right	BO-30	HM871
50,0	6,4	22,0	left	BO-30	HM502

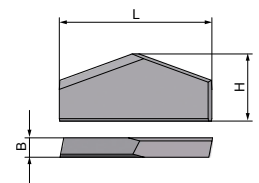

### PLATES SHAPE III

L mm	B mm	H mm	TC grade	Description
25,2	8,0	14,0	B40	HM853

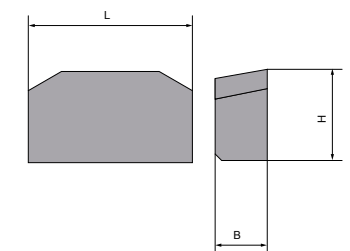

PLATES SHAPE IV

L mm	B mm	H mm	TC grade	Drawing no.
25,0	5,0	6,0	B15	4876

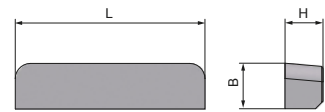

PLATES SHAPE V

L mm	B mm	H mm	TC grade	Description
41,7	15,9	5,0	BO-30	HM851

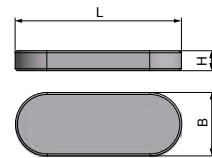

# APPLICATIONS

## ► TC FOR DIFFERENT WEAR SOLUTIONS

### OCTAGONAL SHAPE

Wrench size	Ø D mm	H mm	Angle	TC grade	Description
7,5	7,95	10,0	80	BO-30	HM815
7,5	7,95	15,5	80	B20, BO-30	HM852
10,0	10,6	15,0	80	B10F, B15, B20, BO-30	HM863
14,5	15,5	20,0	80	B20	HM1051

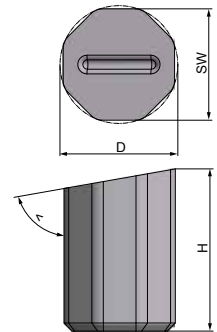

### FLAT TOP INSERTS

Ø D mm	H mm	TC grade	Description
10,3	7,6	B25	4490
10,3	10,0	B25	4429

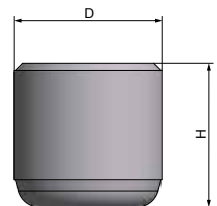

# EXTENSIVE WEAR PROTECTION



## > OVERVIEW

BETEK can provide the appropriate stud welding machine for the Tung-Studs wear protection system.

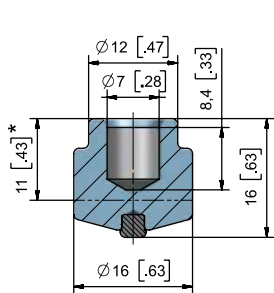

• **BTS01** BTSD16/16

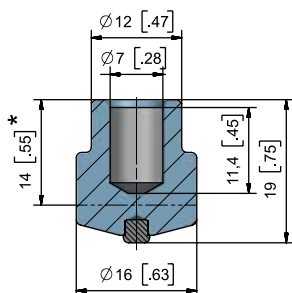

• **BTS02** BTSD16/19

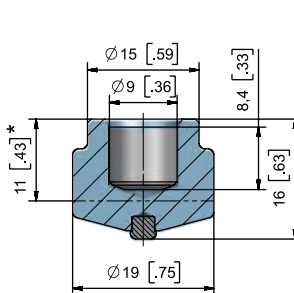

• **BTS03** BTSD19/16

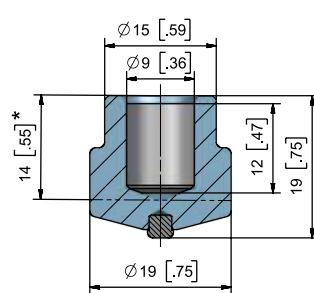

• **BTS04** BTSD19/19

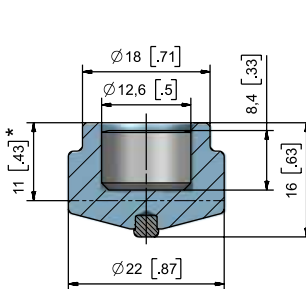

• **BTS05** BTSD22/16

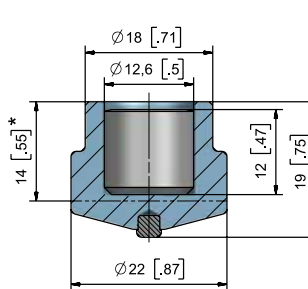

• **BTS06** BTSD22/19

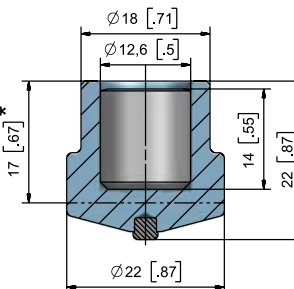

• **BTS07** BTSD22/22

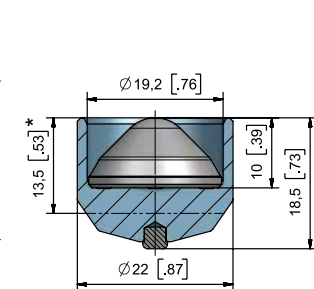

• **BTS08** BTSD22/18,5SG

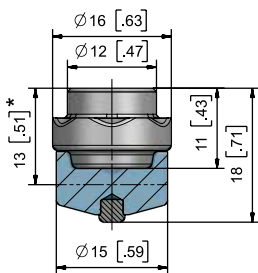

• **BTS10B** BTSD16/18B

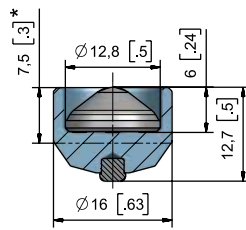

• **BTS20** BTSD16/12,5SG

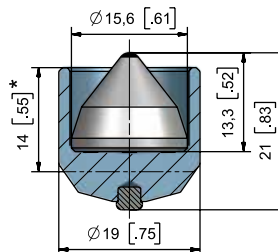

• **BTS100** BTSD19/15,6SG



\*Height after welding

# ➤ BETEK

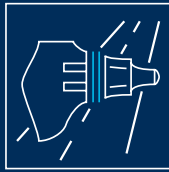

- ROAD MILLING
- SURFACE MINING
- STABILISING

## SURFACE TECHNOLOGIES



- FOUNDATION DRILLING
- MINING
- TRENCHING
- TUNGSTUDS
- DRUM CUTTERS

## UNDERGROUND TECHNOLOGIES



- AGRICULTURE
- GRADER TOOLS
- FORESTRY & RECYCLING

## ENVIRONMENTAL TECHNOLOGIES



- CRUSHING & MIXING
- TUNGSTEN CARBIDE
- RAIL TRACK CONSTRUCTION
- INDUSTRIAL SOLUTIONS

## INDUSTRIAL TECHNOLOGIES



- TIRE STUDS
- SCARIFIER CUTTERS
- POLE TIPS
- HORSESHOE TIPS

## ➤ SITEK A BETEK BRAND



Service number  
+49 (0) 7422. 565-0

info@betek.de  
[www.betek.de](http://www.betek.de)